

Installation Guide

Z5226

Rear Suspension Cradle - Mount Kit

Suits: Chevrolet Camaro 09 - on

(Always refer to the current catalogue for complete application listings)

N.B: These instructions should be used in conjunction with the workshop manual.

1. Raise and support vehicle on hoist or alternatively on safety stands.
2. Remove rear suspension cradle as per relevant workshop or manufacturers repair manual.
3. Remove the OE cradle bushes from the front and rear mount points on the left and right hand sides.
4. As per diagrams below grease and install the supplied bushes and center sleeves.

FRONT MOUNT
TOP BUSH 67465

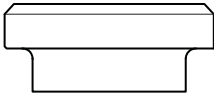

CRADLE
FRONT MOUNT

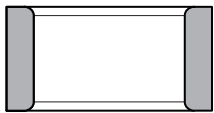

SUPPLIED
CRUSH TUBE

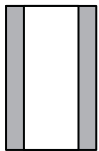

FRONT MOUNT
LOWER BUSH 67466

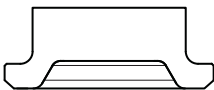

RE-USE FRONT
OE WASHER

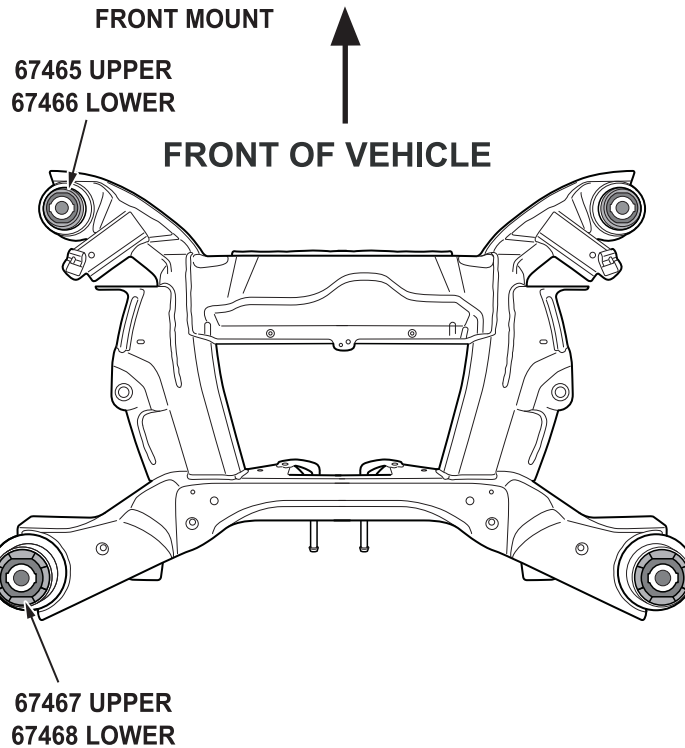
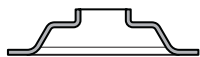

SPIGOT OUT OF CHASSIS



REAR MOUNT
TOP BUSH 67467

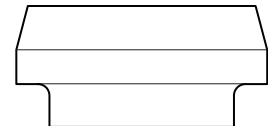

CRADLE REAR MOUNT

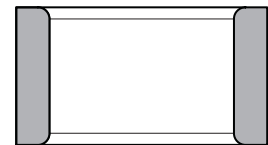

SUPPLIED STEPPED
CRUSH TUBE

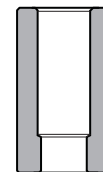

REAR MOUNT
LOWER BUSH 67468

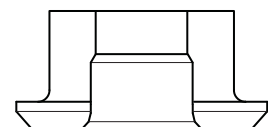

RE-USE REAR
OE WASHER

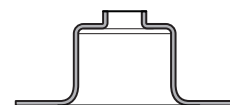

5. Re-install rear suspension cradle into vehicle as per relevant workshop or manufacturers repair manuals.
6. We recommend a 4 wheel alignment be carried out at this time.

N.B: It is recommended that a licenced workshop or trades person carry out the above procedure and that workshop manual and relevant safety procedures are followed in addition to the above.